

R 450 M & T

A.V.R.

Installation and maintenance

R 450 M & T

A.V.R.

This manual concerns the alternator AVR which you have just purchased.

We wish to draw your attention to the contents of this maintenance manual. By following certain important points during installation, use and servicing of your AVR, you can look forward to many years of trouble-free operation.

SAFETY MEASURES

Before using your machine for the first time, it is important to read the whole of this installation and maintenance manual.

All necessary operations and interventions on this machine must be performed by a qualified technician.

Our technical support service will be pleased to provide any additional information you may require.

The various interventions described in this manual are accompanied by recommendations or symbols to alert the user to potential risks of accidents. It is vital that you understand and take notice of the various warning symbols used.

WARNING

Warning symbol for an operation capable of damaging or destroying the machine or surrounding equipment.



Warning symbol for general danger to personnel.



Warning symbol for electrical danger to personnel.

Note: All rights are reserved to modify the characteristics of the products at any time in order to incorporate the latest technological developments. The information contained in this document may therefore be changed without notice.

R 450 M & T

A.V.R.

CONTENTS

1 - GENERAL INFORMATION	4
1.1 - Description	4
1.2 - Identification	4
1.3 - Tools	4
2 - POWER SUPPLY	5
2.1 - AREP excitation system	5
2.2 - PMG excitation system	6
2.3 - SHUNT or separate excitation system	7
3 - TECHNICAL CHARACTERISTICS	8
3.1 - Electrical characteristics	8
3.2 - Configurations	8
3.3 - U/F and LAM functions	12
3.4 - Typical effects of the LAM with a diesel engine with or without a LAM (U/F only)	12
3.5 - AVR options	13
4 - INSTALLATION - COMMISSIONING	14
4.1 - Electrical checks on the AVR	14
4.2 - Setting up	14
4.3 - Electrical faults	17
5 - SPARE PARTS	18
5.1 - Designation	18
5.2 - Technical support service	18



All servicing or repair operations performed on the AVR should be undertaken by personnel trained in the commissioning, servicing and maintenance of electrical and mechanical components.

Copyright 2005 : MOTEURS LEROY-SOMER

This document is the property of :
MOTEURS LEROY-SOMER

It may not be reproduced in any form without prior authorization.

All brands and models have been registered and patents applied for.

R 450 M & T A.V.R.

2 - POWER SUPPLY

Both the AREP & PMG excitation systems are controlled by the AVR.

2.1 - AREP excitation system

With AREP excitation, the electronic AVR is powered by two auxiliary windings which are independent of the voltage sensing circuit.

The first winding has a voltage proportional

to the alternator main voltage (Shunt characteristic), the second one has a voltage proportional to the stator current (compound characteristic : Booster effect).

The power supply voltage is rectified and filtered before being used by the AVR monitoring transistor.

The rotating switch should be in the AREP position (see 3.2.3).

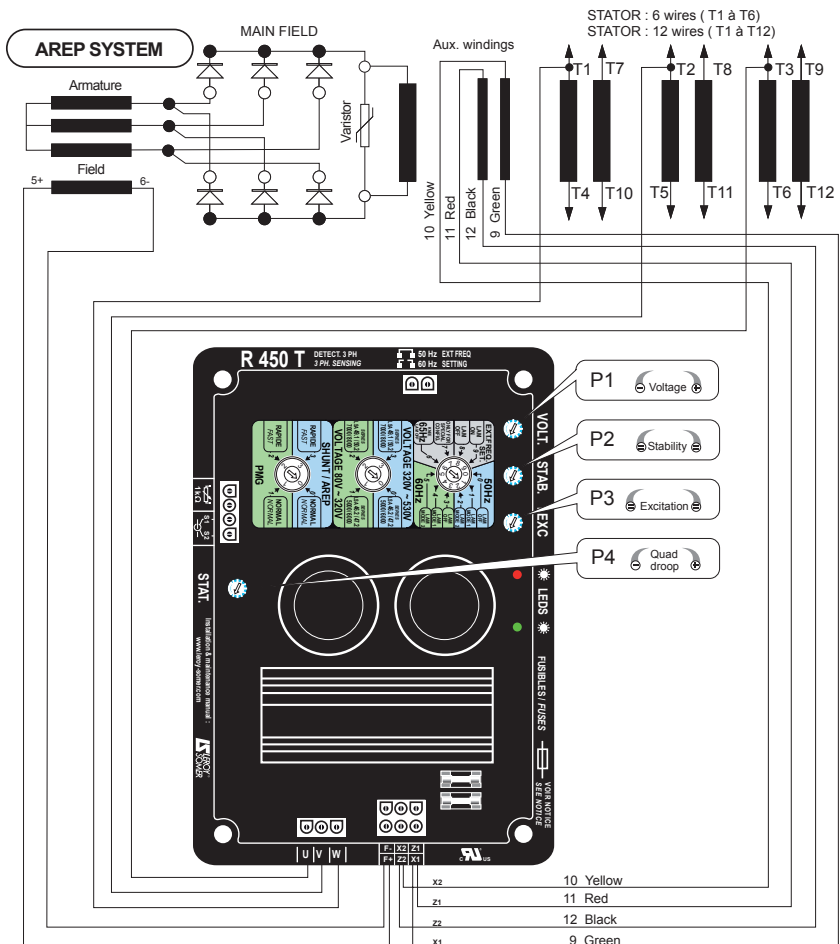

R 450 M & T A.V.R.

2.2 - PMG excitation system

With **PMG** excitation, a permanent magnet generator (PMG) added to the alternator supplies the AVR with voltage which is independent of the main alternator winding. These two excitation principles provide the machine with a short-circuit current overload capacity of 3 IN for 10 s.

The AVR monitors the alternator output voltage by adjusting the excitation current. The rotating switch should be in the PMG position (see 3.2.3).

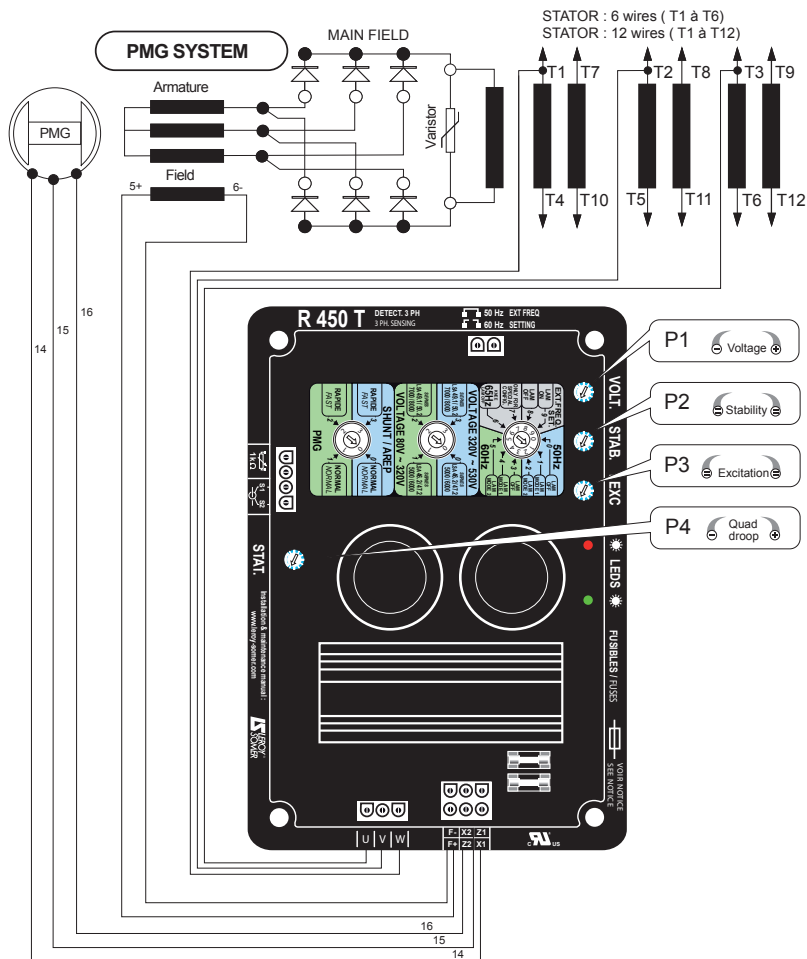

R 450 M & T

A.V.R.

2.3 - SHUNT or separate excitation system

With SHUNT excitation, the AVR is powered by the main winding (100V to 140V - 50/60 Hz) by using X1, X2 on the AVR.

The rotating switch should be in the AREP position (see 3.2.3).

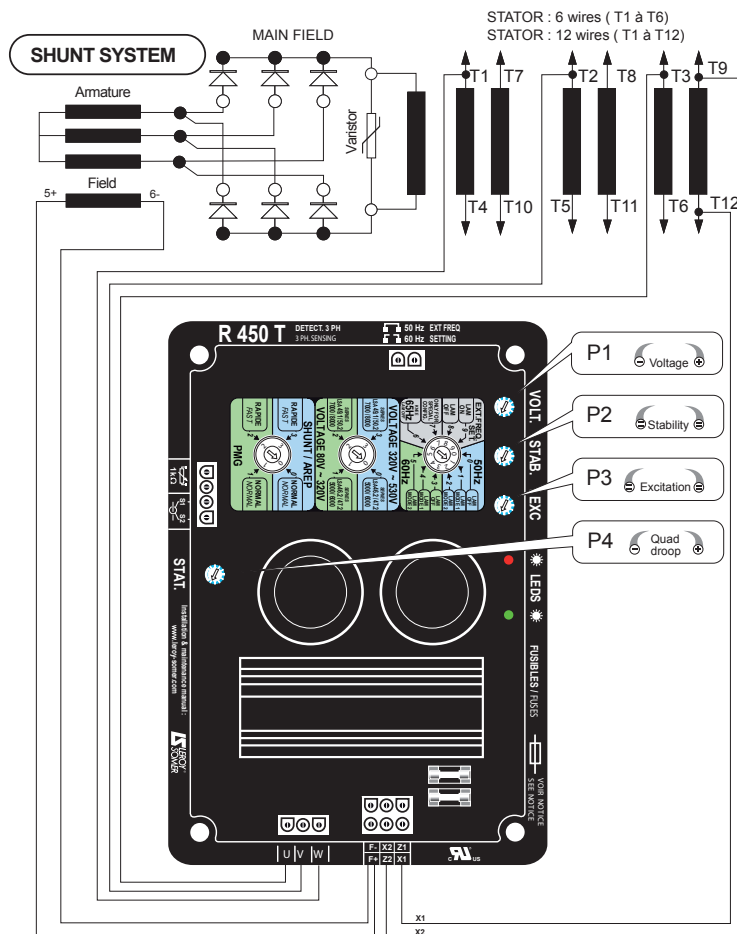

R 450 M & T

A.V.R.

3 - TECHNICAL CHARACTERISTICS

3.1 - Electrical characteristics

- maximum power supply: 150V - 50/60 Hz
- Rated overload current: 10 A - 10 s
- Electronic protection:
 - In the case of a short-circuit, the excitation current is reduced to a value less than 1A after 10 s
 - In the event of loss of voltage reference, the excitation current is reduced to a value less than 1A after 1s for AREP/SHUNT, 10 s for PMG.
 - In the event of overexcitation, the current is reduced as indicated in the next diagram (see 3.2.1.4).
- Fuses: F1 on X1 and F2 on Z2 10A, 250V.
- Voltage sensing
 - 0-110 V terminals = 95 to 140 V
 - 0-220 V terminals = 170 to 260 V
 - 0-380 V terminals = 340 to 528 V

For other voltages, a transformer should be used.

- Voltage regulation: $\pm 0.5\%$.
- Current sensing: (parallel operation): input S1, S2 intended for 1 C.T. $< 2.5 \text{ VA cl1}$, secondary 1 A or 5 A.

3.2 - Configurations:

3.2.1 - Settings

3.2.1.1 - Voltage

Voltage adjustment via potentiometer **P1** in the ranges described in the table below:

For 50 and 60 Hz	Max.
High range	$U_n \leq 530 \text{ V}$
Medium range	$U_n \leq 252 \text{ V}$

WARNING

The allowed adjustment range is $\pm 5\%$; when the setting exceeds these limits, please check that it is conform with the power table.

3.2.1.2 - Quadrature droop:

Quadrature droop adjustment via potentiometer **P4** within a range :

- from 0 to 8% with a PF=0.8 for 400V applications.
- From 0 to 14% with a PF=0.8 for 240V applications.
- From 0 to 8% for 110V applications with a step-up transformer (ratio of 4) placed on the voltage reference.

The potentiometer P4 has a non linear response. Then, when a 1A secondary CT is connected the effective range starts from the the second 1/3 of P4 range and in the case of a 5A secondary CT the effective range starts from the first 1/3.

When a 5ACT is used, the adjustment range is higher, so P4 must be set to the first 1/4 (anti-clockwise) and then progressively increase it.

WARNING

The CT must be connected.

3.2.1.3 - Stability:

Stability adjustment via potentiometer **P2**. Selection of rotating switch according to the machine type and the response time as indicated in paragraph 3.2.3.

3.2.1.4 - Excitation limitation:

Excitation limitation adjustment via potentiometer **P3** as described below.

The excitation current limitation threshold in steady state is set by a potentiometer at 110% of the rated value. The adjustment is made by the operator during the on-load test at rated power by tuning the potentiometer. When the excitation current exceeds this value, a counter is activated at the speed of one record per second for 90 s. When this time is elapsed, the current is reduced to the value of the rated excitation current. If in the meantime the excitation current drops below the threshold value, the counter counts down at the same speed.

R 450 M & T

A.V.R.

WARNING

The limitation threshold must be adjustable between 1 and 5.5 A. The genset breaker must be open during the short circuit. If the genset is restarted in short circuit, there is a excitation build up during 10s again at the maximum value.

Operation between 3 and 6 In when short-circuited:

The excitation current ceiling during a short-circuit equals 2.9 times the fixed threshold when setting the permitted excitation ceiling in continuous operation. When the threshold is exceeded for a period = 10 s the current is reduced to a value between 0.5 and 0.7 A (shutdown).

NB: Even if the AVR is limiting the exciter field current to a value less than 1A, the generator will continue to supply the fault

current. In all operating conditions the maximum excitation current is clamped to 9.5 A \pm 0.5 A.

Overrun indications:

One green LED:

- Lights up when the excitation current is below the continuous operation threshold. It signals the AVR normal operation.
- Turns off when the excitation current ceiling used to obtain short-circuit operation is reached and when the excitation current is reduced to the shutdown value.
- Flashes when the over excitation timer is decrementing.

NB: After the short circuit is cleared, the output voltage is limited to about 70% of the rated voltage. This avoids no load overvoltage for machine which no load exciter current is less than the shutdown current (only in AREP).

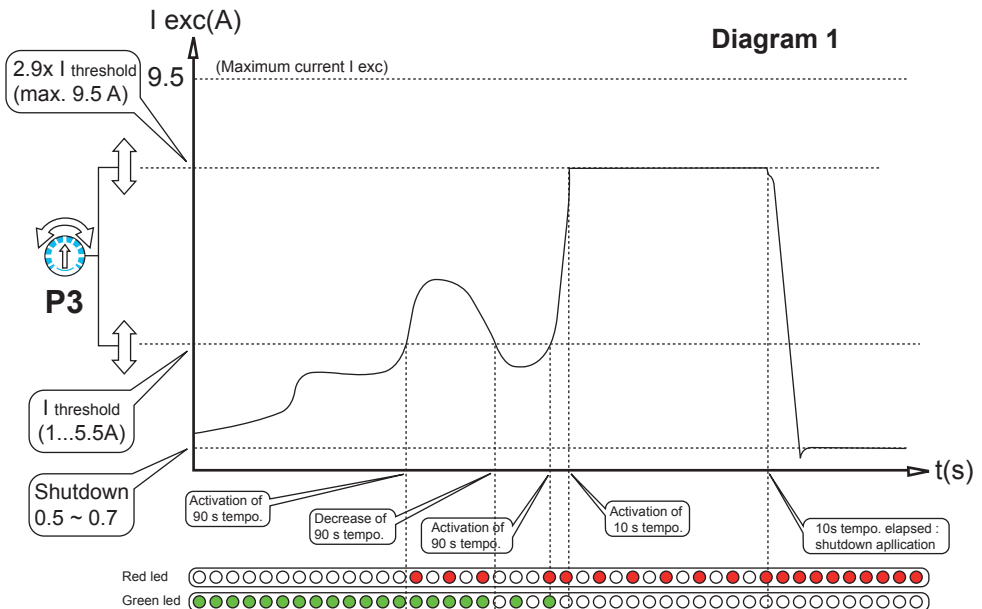

R 450 M & T

A.V.R.

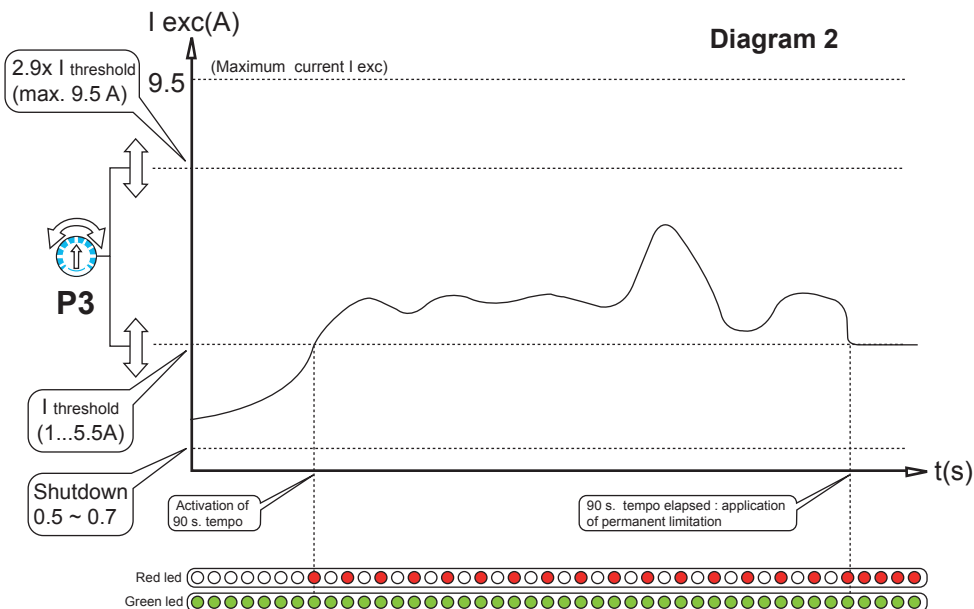

Red LED:

- Lights up simultaneously with the green led when the continuous operation threshold is reached for more than 90 s and the excitation current is reduced to the continuous operation threshold. It is used to set the excitation current ceiling

- Turns off when the excitation current is less than the setting value

- Flashes when the excitation current is above the continuous operation threshold during less than 90 s.

When the green led is off :

- flashes in a case of loss of voltage sensing <1s or 10s for PMG excitation.

- turns on if $I_{exc} = I_{shutdown}$.

WARNING

In the case of overload protection activation, a voltage drop will appear with a value sometimes higher than 10% of the reference voltage.

The UnderVoltage protection is not achieved by the AVR. Customer must ensure that his installation load is correctly protected against undervoltage.

During load rejection, the overvoltage is observed and takes a few seconds to be cleared.

R 450 M & T

A.V.R.

3.2.2 - Rotating switch selection: LAM and U/F

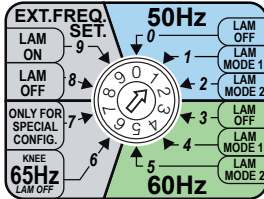

- Pos 0: Change in the voltage according to the U/F ratio, knee-point position at 48 Hz.
- Pos 1: Change in the voltage according to the 2U/F, knee-point position at 48 Hz.
- Pos 2: Change in the voltage according to the self auto-adaptive LAM combined with 2U/F, knee-point position at 48 Hz.
- Pos 3: Change in the voltage according to the U/F ratio, knee-point position at 58 Hz
- Pos 4: Change in the voltage according to the 2U/F, knee-point position at 58 Hz.
- Pos 5: Change in the voltage according to the self auto-adaptive LAM combined with 2U/F, knee-point position at 58 Hz.
- Pos 6: Change in the voltage according to the U/F ratio, knee-point position at 65 Hz (Tractelec application and variable speed above 1800 rpm).
- Pos 7: Special (not used).
- Pos 8: Change in the voltage according to the U/F ratio, knee-point position at 48 Hz or 58 Hz according to selection of the frequency by an external contact.
- Pos 9: Change in the voltage according to LAM 1, knee-point position at 48 Hz or 58 Hz according to selection of the frequency by an external contact

WARNING

For Pavers and hydraulic applications, select positions 0 (50 Hz) or 3 (60 Hz).

3.2.3 Rotating switch: excitation type and time response

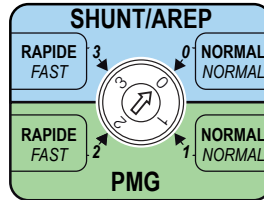

- 0: AREP excitation and normal time response.
 - 3: AREP excitation and fast time response.
 - 1: PMG excitation and normal time response.
 - 2: PMG excitation and fast time response.
- For SHUNT applications, AREP excitation must be selected.

3.2.4 Rotating switch : voltage sensing

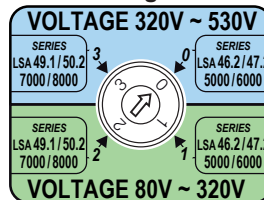

- 0: Voltage from 320 to 530V
 - LSA 46.2/47.2 - 5000 / 6000 series.
- 3: Voltage from 320 to 530V
 - LSA 49.1/50.2 - 7000 / 8000 series.
- 1: Voltage from 80 to 320V
 - LSA 46.2/47.2 - 5000 / 6000 series.
- 2: Voltage from 80 to 320V
 - LSA 49.1/50.2 - 7000 / 8000 series.

R 450 M & T A.V.R.

3.3 - U/F and LAM function

3.3.1 - Frequency variation compared with voltage (without LAM)

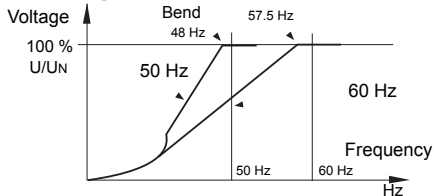

3.3.2 - LAM (Load Acceptance Module) characteristics

3.3.2.1 - Voltage drop

The LAM system is integrated in the AVR. As standard it is active.

Role of the LAM:

On application of a load, the genset rotation speed decreases. When it falls below the preset frequency threshold, the LAM causes the voltage to drop proportionately to the frequency (LAM1) or to the active power (LAM2) depending on the rotating switch position. This reduces the active load scale applied until the speed returns to its rated value.

Hence the LAM can be used either to reduce the speed variation (frequency) and its duration for a given applied load, or to increase the applied load possible for one speed variation (turbo-charged engine).

To avoid voltage oscillations, the trip threshold for the LAM function should be set approximately 2 Hz below the rated frequency.

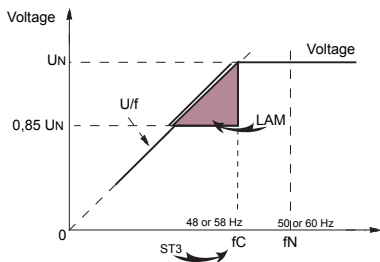

3.3.2.2 - Soft voltage recovery function

During load impacts, the function helps the genset to return to its rated speed faster with a gradual increase in voltage according to the principle:

- If the speed drops between 46 and 50 Hz (in 50Hz operation), the rated voltage is recovered by following a fast gradient.
- If the speed drops below 46 Hz, since the engine needs more help, the voltage follows a slow gradient as it returns to the reference value.

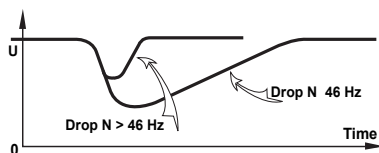

3.4 - Typical effects of the LAM with a diesel engine with or without a LAM (U/F only)

3.4.1 - Voltage

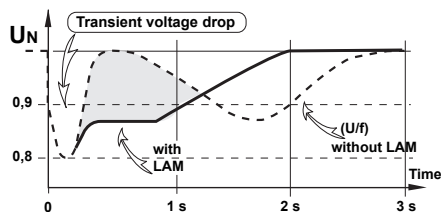

3.4.2 - Frequency

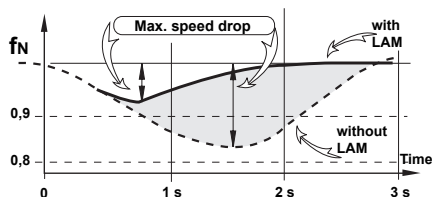

R 450 M & T

A.V.R.

3.4.3 - Power

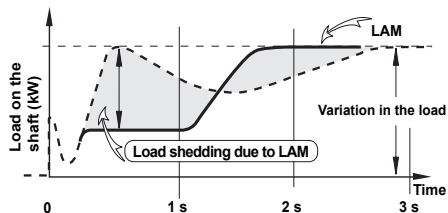

- **R729 module:** same as R726 with additional functions.

- Detection of a diode fault.
- 4-20 mA input.
- Possibility of kVAR regulation.

- **Voltage control:** with an **isolated** D.C. current source applied to the terminals used for the external potentiometer:

- Internal impedance 1.5 k Ω .
- A variation of ± 0.5 V corresponds to a voltage adjustment of $\pm 10\%$.

3.5 - AVR options

- **Current transformer** for parallel operation of...../1 A or 5 A according to the potentiometer P4 position.

- **Voltage transformer**
(adaptation)

- **Remote voltage adjustment potentiometer.**

For a range of variation:

$\pm 5\%$: 470 Ω

$\pm 10\%$: 1 k Ω

the power of the potentiometer can be 0.5 W, 2 W or 3 W.



The potentiometer input must be isolated. Do not connect it to the ground.

- **R 726 module:** regulation system changed to "4-function" (see the maintenance manual and connection diagram).

- PF regulation (2F) .
- Equalization of voltages before paralleling (3 F).
- Possibility of coupling to the mains of alternators already running in parallel (4F).

R 450 M & T

A.V.R.

4-INSTALLATION-COMMISSIONING

4.1 - Electrical checks on the AVR

- Check that all connections have been made properly as shown in the attached wiring diagram.

- Check the rotating switches selections

- frequency,
- type of alternator,
- normal position (response time),
- external potentiometer,
- rated voltage,
- secondary current of the CT used,
- type of excitation.

- R450 optional operating modes

4.2 - Setting up



The various adjustments during tests must be made by a qualified engineer. It is essential that the drive speed specified on the nameplate is reached before commencing adjustment. After operational testing, replace all access panels or covers.





The AVR is used to make any adjustments to the machine.

4.2.1 - Setting up the R450

WARNING

Before using the AVR, make sure that the rotating switches have been correctly configured with AREP/SHUNT or PMG excitation

a) Initial potentiometer settings (see table below)

Action	Factory setting	Pot.
Voltage minimum fully anti-clockwise	400 V - 50 Hz	
Stability	Not set (centre position)	
Excitation ceiling - Factory-sealed	10 A maximum	
Voltage quadrature droop (// operation with C.T.) - 0 quadrature droop fully anti-clockwise	Not set (fully anti-clockwise)	

Stability adjustments in standalone operation

b) Install a D.C. analogue voltmeter (needle dial) cal. 100 V on terminals E+, E- and an A.C. voltmeter cal. 300 - 500 or 1000 V on the alternator output terminals.

c) Check the rotating switch selection.

d) Voltage potentiometer P1 at minimum, fully anti-clockwise.

e) Stability potentiometer P2 around 1/3 in from the anti-clockwise stop.

f) Start the engine and set its speed to a frequency of 48 Hz for 50 Hz, or 58 for 60 Hz.

g) Set the output voltage to the desired value using P1.

- Rated voltage U_N for solo operation (eg. 400 V)

- Or $U_N + 2$ to 4% for parallel operation with C.T. (eg. 410 V -)

If the voltage oscillates, use P2 to make adjustments (try both directions), observing the voltage between E+ and E- (approx. 10 V D.C.). The best response time is obtained at the limit of the instability. If no stable position can be obtained, try selecting the fast position.

h) Check LAM operation: depending on the rotating switch selection.

R 450 M & T

A.V.R.

i) Vary the frequency (speed) around 48 or 58 Hz according to the operating frequency, and check the change in voltage from that observed previously (~ 15%).

j) Readjust the speed of the genset to its rated no-load value.

Adjustments in parallel operation

Before starting work on the alternator, make sure that the speed droop is identical for all engines.

k) Preset for parallel operation (with C.T. connected to S1, S2)

- Potentiometer **P4** (quadrature droop) in 1/4 position in the case of 5A CT and at 1/2 position in the case of 1A CT.

Apply the rated load (PF = 0.8 inductive). The voltage should drop by 2 to 3% (400 V). If it increases, check that neither V and W nor S1 and S2 have been reversed.

l) The no-load voltages should be identical for all the alternators intended to run in parallel.

- Couple the machines in parallel.
- By adjusting the speed, try to obtain 0 kW power exchange.
- By altering the voltage setting P1 on one of the machines, try to cancel (or minimise) the current circulating between the machines.
- From now on, do not touch the voltage settings.

m) Apply the available load (the setting is only correct if a reactive load is available)

- By altering the speed, match the kW (or divide the rated power of the units proportionally)
- By altering the quadrature droop potentiometer **P4**, match or divide the currents.

4.2.2 - Max. excitation adjustment (excitation ceiling)

In standard setting, the potentiometer P3 is in maximum position.

However, for applications requiring an overload protection (see 3.2.1.4), the excitation ceiling must be adjusted by using the following procedures in AREP and PMG.

Method 1 :

- Connect the AVR to the alternator
- apply load to 110% of rated machine rated at PF=0.8, the green led is on and the red one is off.

- record the excitation current value
- adjust P3 until obtaining the red led flashing, the green one is always on.

- decrease the load to 100% and make sure that the red led is off.

- Increase the load at 115%, check that the red LED flashes during 90 seconds and that the excitation current is brought back to the above adjusted value ($I_{\text{exc adjusted}}$).

Method 2 :

The rated excitation current (see machine plate) must be multiplied by 1.1 and the obtained value is used to set the potentiometer P3 at the right position. The following table must be used.

Position of P3	I exc (A)
8h	1
9h	1.55
10h	1.95
11h	2.5
12h	3.15
13h	3.65
14h	4.25
15h	4.7
16h	5.15

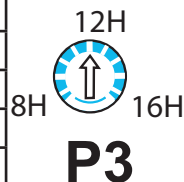

NB: In the case of a permanent short-circuit, the excitation current must reach $2.9 \times I_{\text{exc adjusted}}$ during 1 second in AREP or 10 seconds in PMG and shuts down to a value less than 1A

R 450 M & T

A.V.R.



When the excitation current is set to the rated value, a voltage dip is observed in excitation current limit when the limitation is activated and the current limit is reached.

4.2.3 - Special type of use

WARNING

The excitation circuit E+, E- must not be left open when the machine is running: this will irreparably damage the AVR.

4.2.3.1 - R450 (SHUNT) field weakening

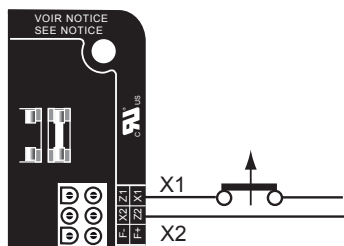

The exciter is switched off by disconnecting the AVR power supply (1 wire - X1 or X2)
Contact rating: 16 A - 250 V A.C.

4.2.3.2 - R450 (AREP/PMG) field weakening

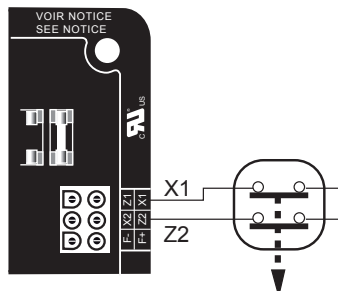

The exciter is switched off by disconnecting the AVR power supply (1 wire on each auxiliary winding) - contact rating 16 A - 250 V A.C.

Connection is identical for resetting the AVR internal protection.



If field weakening is used, provide field forcing.

4.2.3.3 - R450 field forcing

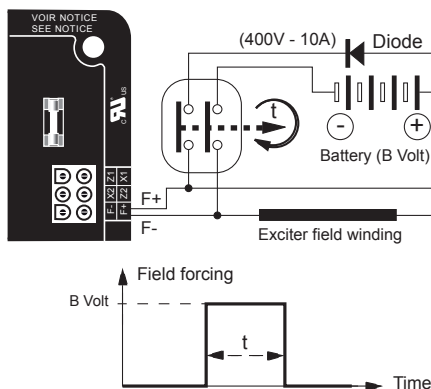

Applications	B Volt	Time t
Guaranteed voltage build-up	12 (1A)	1 - 2 s
Parallel operation, de-energized	12 (1A)	1 - 2 s
Parallel operation, at standstill	12 (1A)	5 - 10 s
Frequency starting	12 (1A)	5 - 10 s
Sustained voltage on overload	12 (1A)	5 - 10 s

R 450 M & T A.V.R.

4.3 - Electrical faults

Fault	Action	Measurements	Check/Cause
No voltage at no load on start-up	Connect a new battery of 4 to 12 V to terminals E- and E+, respecting the polarity, for 2 to 3 seconds	The alternator builds up and its voltage is still correct when the battery is removed	- Lack of residual magnetism
		The alternator builds up but its voltage does not reach the rated value when the battery is removed	- Check the connection of the voltage reference to the AVR - Faulty diodes - Armature short-circuit
		The alternator builds up but its voltage disappears when the battery is removed	- Faulty AVR - Field windings disconnected - Revolving field coil open circuit. Check the resistance
Voltage too low	Check the drive speed	Correct speed	Check the AVR connections (AVR may be faulty) - Field windings short-circuited - Rotating diodes burnt out - Revolving field coil short-circuited - Check the resistance
		Speed too low	Increase the drive speed (Do not touch the AVR voltage pot. (P1) before running at the correct speed)
Voltage too high	Adjust AVR voltage potentiometer	Adjustment ineffective	- Faulty AVR - 1 faulty diode
Voltage oscillations	Adjust AVR stability potentiometer	If no effect: try normal/fast recovery modes	- Check the speed: possibility of cyclic irregularity - Loose connections - Faulty AVR - Speed too low when on load (or U/F knee-point set too high)
Voltage correct at no load and too low when on load (*)	Run at no load and check the voltage between E+ and E- on the AVR	Voltage between E+ and E- AREP/PMG < 10 V	- Check the speed (or U/F knee-point set too high)
		Voltage between E+ and E- AREP/PMG > 15 V	- Faulty rotating diodes - Short-circuit in the revolving field coil. Check the resistance - Faulty exciter armature
(*) Caution: For single-phase operation, check that the sensing wires coming from the AVR are correctly connected to the operating terminals.			
Voltage disappears during operation (**)	Check the AVR, the surge suppressor, the rotating diodes, and replace any defective components	The voltage does not return to the rated value	- Exciter winding open circuit - Faulty exciter armature - Faulty AVR - Revolving field coil open circuit or short-circuited
(**) Caution: Internal protection may be activated (overload, open circuit, short-circuit)			



Caution: After operational testing or troubleshooting, replace all access panels or covers.

R 450 M & T A.V.R.

5 - SPARE PARTS

5.1 - Designation

Description	Type	Code
Voltage regulator (AVR)	R 450 M	AEM 110 RE 032
Voltage regulator (AVR)	R 450 T	AEM 110 RE 033

5.2 - Technical support service

Our technical support service will be pleased to provide any additional information you may require.

When ordering spare parts, you should indicate the AVR type and code number.

Address your enquiry to your usual contact.

Our extensive network of service centres can dispatch the necessary parts without delay.

To ensure correct operation and the safety of our machines, we recommend the use of original manufacturer spare parts.

In the event of failure to comply with this advice, the manufacturer cannot be held responsible for any damage.

R 450 M & T
A.V.R.

